

700MHz – 1050MHz High Linearity Direct Quadrature Modulator

FEATURES

- Frequency Range: 700MHz to 1050MHz
- High OIP3: +22.9dBm at 850MHz
- Low Output Noise Floor at 5MHz Offset:
 - No RF: -160.3dBm/Hz
 - $P_{OUT} = 4\text{dBm}$: -154dBm/Hz
- 3-Ch CDMA2000 ACPR: -71.4dBc at 850MHz
- Integrated LO Buffer and LO Quadrature Phase Generator
- 50Ω AC-Coupled Single-Ended LO and RF Ports
- 50Ω DC Interface to Baseband Inputs
- Low Carrier Leakage: -43dBm at 850MHz
- High Image Rejection: -46dBc at 850MHz
- 16-Lead 4mm × 4mm QFN Package

APPLICATIONS

- Infrastructure Tx for Cellular Bands
- Image Reject Up-Converters for Cellular Bands
- Low-Noise Variable Phase-Shifter for 700MHz to 1050MHz Local Oscillator Signals
- RFID Reader

DESCRIPTION

The LT[®]5568 is a direct I/Q modulator designed for high performance wireless applications, including wireless infrastructure. It allows direct modulation of an RF signal using differential baseband I and Q signals. It supports PHS, GSM, EDGE, TD-SCDMA, CDMA, CDMA2000, W-CDMA, and other systems. It may also be configured as an image reject upconverting mixer, by applying 90° phase-shifted signals to the I and Q inputs. The I/Q baseband inputs consist of voltage-to-current converters that in turn drive double-balanced mixers. The outputs of these mixers are summed and applied to an on-chip RF transformer, which converts the differential mixer signals to a 50Ω single-ended output. The four balanced I and Q baseband input ports are intended for DC coupling from a source with a common mode voltage level of about 0.5V. The LO path consists of an LO buffer with single-ended input, and precision quadrature generators that produce the LO drive for the mixers. The supply voltage range is 4.5V to 5.25V.

LT, LTC and LT are registered trademarks of Linear Technology Corporation. All other trademarks are the property of their respective owners.

TYPICAL APPLICATION

700MHz to 1050MHz Direct Conversion Transmitter Application

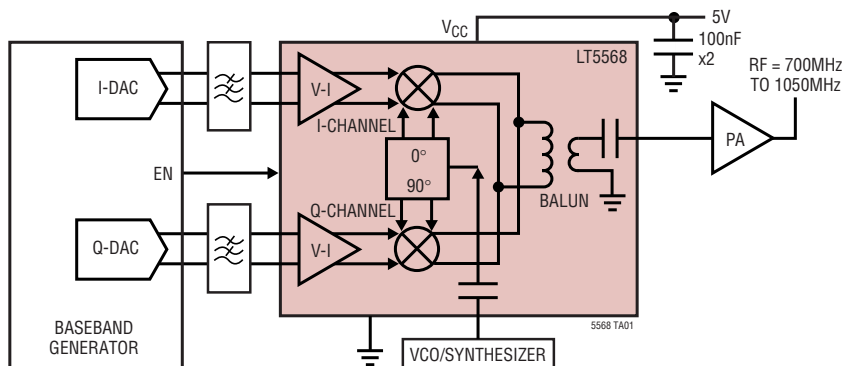

CDMA2000 ACPR, AItCPR and Noise vs RF Output Power at 850MHz for 1 and 3 Carriers

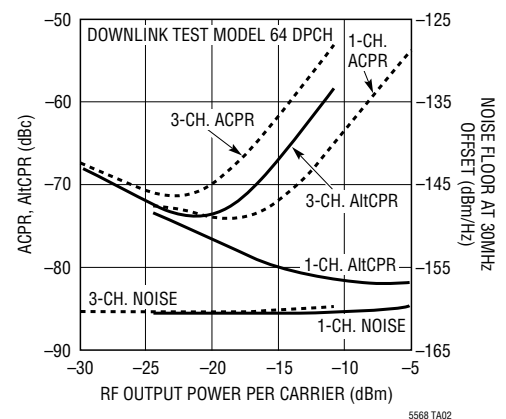

5568 TA02

ABSOLUTE MAXIMUM RATINGS

(Note 1)

| | |
|---|----------------------------|
| Supply Voltage | 5.5V |
| Common Mode Level of BBPI, BBMI and BBPQ, BBMQ | 2.5V |
| Operating Ambient Temperature (Note 2) | -40°C to 85°C |
| Storage Temperature Range..... | -65°C to 125°C |
| Voltage on any Pin Not to Exceed..... | -500mV to $V_{CC} + 500mV$ |

PACKAGE/ORDER INFORMATION

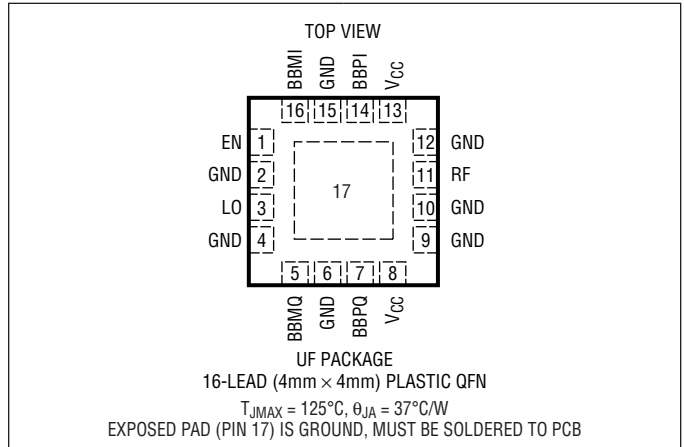

| | |
|---|-----------------|
| ORDER PART NUMBER | UF PART MARKING |
| LT5568EUF | 5568 |
| Order Options Tape and Reel: Add #TR Lead Free: Add #PBF Lead Free Tape and Reel: Add #TRPBF Lead Free Part Marking: http://www.linear.com/leadfree/ | |

Consult LTC Marketing for parts specified with wider operating temperature ranges.

ELECTRICAL CHARACTERISTICS

$V_{CC} = 5V$, EN = High, $T_A = 25^{\circ}C$, $f_{LO} = 850MHz$, $f_{RF} = 852MHz$, $P_{LO} = 0dBm$.
 BBPI, BBMI, BBPQ, BBMQ inputs 0.54V_{DC}, Baseband Input Frequency = 2MHz, I&Q 90° shifted (upper side-band selection).
 $P_{RF, OUT} = -10dBm$, unless otherwise noted. (Note 3)

| SYMBOL | PARAMETER | CONDITIONS | MIN | TYP | MAX | UNITS |
|--------------------------|-------------------------------------|---|-----|------------------------|-----|----------------------------|
| RF Output (RF) | | | | | | |
| f_{RF} | RF Frequency Range | -3dB Bandwidth | | 0.6 to 1.2 | | GHz |
| | RF Frequency Range | -1dB Bandwidth | | 0.7 to 1.05 | | GHz |
| $S_{22, ON}$ | RF Output Return Loss | EN = High (Note 6) | | -14 | | dB |
| $S_{22, OFF}$ | RF Output Return Loss | EN = Low (Note 6) | | -12 | | dB |
| NFloor | RF Output Noise Floor | No Input Signal (Note 8) $P_{OUT} = 4dBm$ (Note 9) $P_{OUT} = 4dBm$ (Note 10) | | -160.3 -154 -154 | | dBm/Hz dBm/Hz dBm/Hz |
| G_p | Conversion Power Gain | $P_{OUT}/P_{IN, I\&Q}$ | -9 | -6.8 | -3 | dB |
| G_v | Conversion Voltage Gain | $20 \cdot \log(V_{OUT, 50\Omega}/V_{IN, DIFF, I \text{ or } Q})$ | | -6.8 | | dB |
| P_{OUT} | Absolute Output Power | 1V _{P-P} DIFF CW Signal, I and Q | | -2.8 | | dBm |
| $G_{3LO \text{ vs } LO}$ | 3 • LO Conversion Gain Difference | (Note 17) | | -23 | | dB |
| OP1dB | Output 1dB Compression | (Note 7) | | 8.3 | | dBm |
| OIP2 | Output 2nd Order Intercept | (Notes 13, 14) | | 63 | | dBm |
| OIP3 | Output 3rd Order Intercept | (Notes 13, 15) | | 22.9 | | dBm |
| IR | Image Rejection | (Note 16) | | -46 | | dBc |
| LOFT | Carrier Leakage (LO Feedthrough) | EN = High, $P_{LO} = 0dBm$ (Note 16) EN = Low, $P_{LO} = 0dBm$ (Note 16) | | -43 -65 | | dBm dBm |

ELECTRICAL CHARACTERISTICS $V_{CC} = 5V$, EN = High, $T_A = 25^{\circ}C$, $f_{LO} = 850MHz$, $f_{RF} = 852MHz$, $P_{LO} = 0dBm$.
 BBPI, BBMI, BBPQ, BBMQ inputs $0.54V_{DC}$, Baseband Input Frequency = 2MHz, I&Q 90° shifted (upper side-band selection).
 $P_{RF, OUT} = -10dBm$, unless otherwise noted. (Note 3)

| SYMBOL | PARAMETER | CONDITIONS | MIN | TYP | MAX | UNITS |
|----------------------|--------------------------------|--------------------|-----|------------|-----|-------|
| LO Input (LO) | | | | | | |
| f_{LO} | LO Frequency Range | | | 0.6 to 1.2 | | GHz |
| P_{LO} | LO Input Power | | -10 | 0 | 5 | dBm |
| $S_{11, ON}$ | LO Input Return Loss | EN = High (Note 6) | | -11.4 | | dB |
| $S_{11, OFF}$ | LO Input Return Loss | EN = Low (Note 6) | | -2.7 | | dB |
| NF_{LO} | LO Input Referred Noise Figure | (Note 5) at 850MHz | | 12.7 | | dB |
| G_{LO} | LO to RF Small Signal Gain | (Note 5) at 850MHz | | 23.8 | | dB |
| $IIP3_{LO}$ | LO Input 3rd Order Intercept | (Note 5) at 850MHz | | -11.5 | | dBm |

Baseband Inputs (BBPI, BBMI, BBPQ, BBMQ)

| | | | | | | |
|---------------------|-------------------------------|---|--|------|--|-----------------|
| BW_{BB} | Baseband Bandwidth | -3dB Bandwidth | | 380 | | MHz |
| V_{CMBB} | DC Common Mode Voltage | (Note 4) | | 0.54 | | V |
| $R_{IN, SE}$ | Single-Ended Input Resistance | (Note 4) | | 48 | | Ω |
| P_{LO2BB} | Carrier Feedthrough on BB | $P_{OUT} = 0$ (Note 4) | | -38 | | dBm |
| IP1dB | Input 1dB Compression Point | Differential Peak-to-Peak (Notes 7, 18) | | 4.3 | | $V_{P-P, DIFF}$ |
| $\Delta G_{I/Q}$ | I/Q Absolute Gain Imbalance | | | 0.07 | | dB |
| $\Delta \phi_{I/Q}$ | I/Q Absolute Phase Imbalance | | | 0.45 | | Deg |

Power Supply (V_{CC})

| | | | | | | |
|---------------|----------------------------|----------------------------|-----|-----|------|---------|
| V_{CC} | Supply Voltage | | 4.5 | 5 | 5.25 | V |
| $I_{CC, ON}$ | Supply Current | EN = High | 80 | 117 | 165 | mA |
| $I_{CC, OFF}$ | Supply Current, Sleep Mode | EN = 0V | | | 50 | μA |
| t_{ON} | Turn-On Time | EN = Low to High (Note 11) | | 0.3 | | μs |
| t_{OFF} | Turn-Off Time | EN = High to Low (Note 12) | | 1.4 | | μs |

Enable (EN), Low = Off, High = On

| | | | | | | |
|--------|--|----------------------|-----|-----|-----|--------------|
| Enable | Input High Voltage Input High Current | EN = High EN = 5V | 1.0 | 230 | | V μA |
| Sleep | Input Low Voltage Input Low Current | EN = Low EN = 0V | | 0 | 0.5 | V μA |

Note 1: Absolute Maximum Ratings are those values beyond which the life of a device may be impaired.

Note 2: Specifications over the -40°C to 85°C temperature range are assured by design, characterization and correlation with statistical process controls.

Note 3: Tests are performed as shown in the configuration of Figure 7.

Note 4: On each of the four baseband inputs BBPI, BBMI, BBPQ and BBMQ.

Note 5: $V(BBPI) - V(BBMI) = 1V_{DC}$, $V(BBPQ) - V(BBMQ) = 1V_{DC}$.

Note 6: Maximum value within -1dB bandwidth.

Note 7: An external coupling capacitor is used in the RF output line.

Note 8: At 20MHz offset from the LO signal frequency.

Note 9: At 20MHz offset from the CW signal frequency.

Note 10: At 5MHz offset from the CW signal frequency.

Note 11: RF power is within 10% of final value.

Note 12: RF power is at least 30dB lower than in the ON state.

Note 13: Baseband is driven by 2MHz and 2.1MHz tones. Drive level is set in such a way that the two resulting RF tones are -10dBm each.

Note 14: IM2 measured at LO frequency + 4.1MHz.

Note 15: IM3 measured at LO frequency + 1.9MHz and LO frequency + 2.2MHz.

Note 16: Amplitude average of the characterization data set without image or LO feedthrough nulling (unadjusted).

Note 17: The difference in conversion gain between the spurious signal at $f = 3 \cdot LO - BB$ versus the conversion gain at the desired signal at $f = LO + BB$ for $BB = 2MHz$ and $LO = 850MHz$.

Note 18: The input voltage corresponding to the output P1dB.

TYPICAL PERFORMANCE CHARACTERISTICS $V_{CC} = 5V$, $EN = High$, $T_A = 25^\circ C$, $f_{LO} = 850MHz$, $P_{LO} = 0dBm$. BBPI, BBMI, BBPQ, BBMQ inputs $0.54V_{DC}$, Baseband Input Frequency $f_{BB} = 2MHz$, I&Q 90° shifted. $f_{RF} = f_{BB} + f_{LO}$ (upper sideband selection). $P_{RF, OUT} = -10dBm$ ($-10dBm/$ tone for 2-tone measurements), unless otherwise noted. (Note 3)

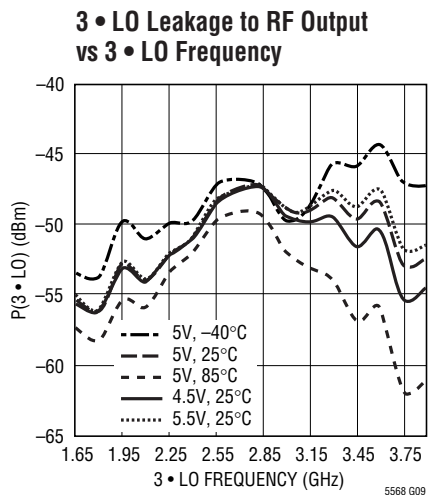
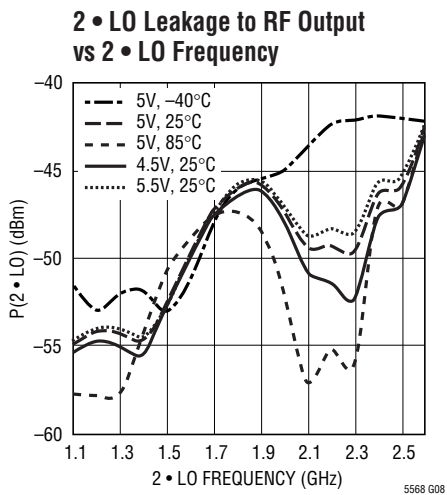
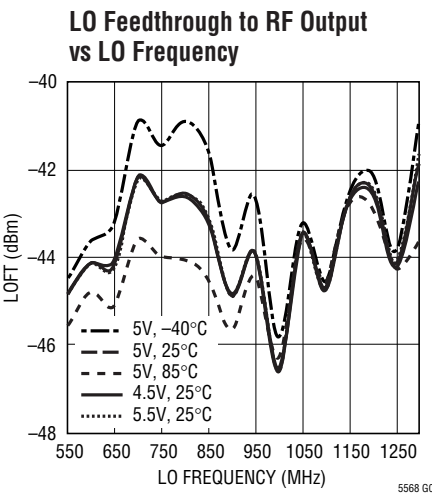
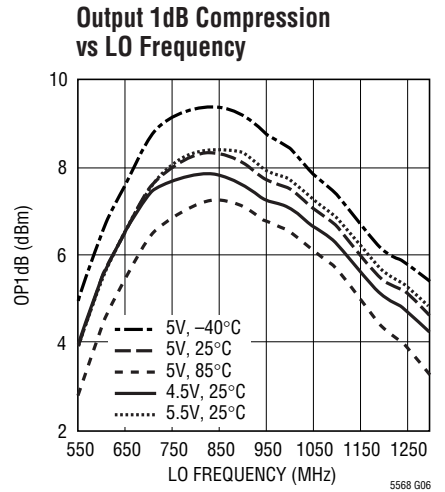
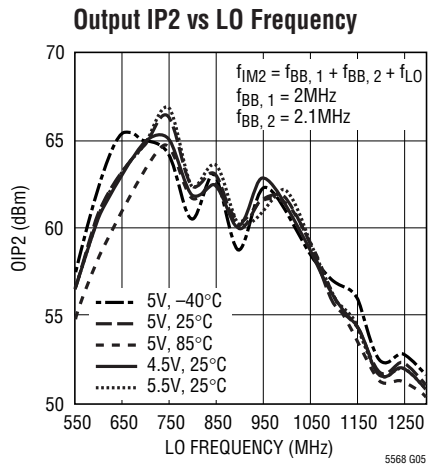
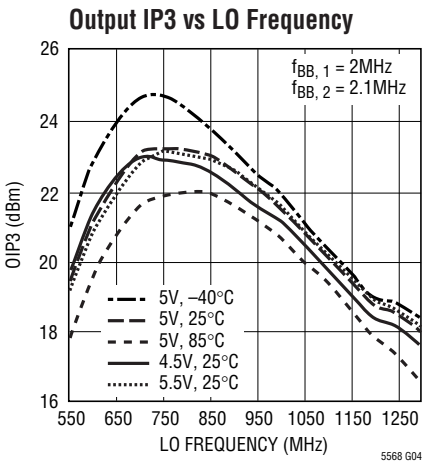
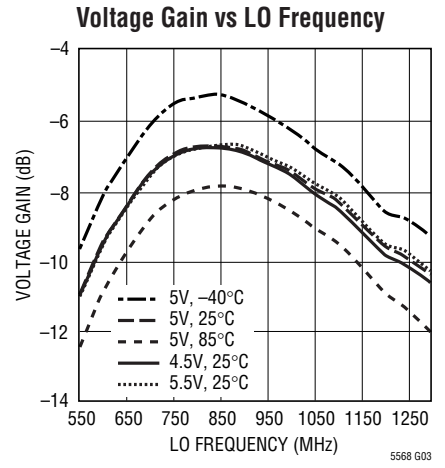
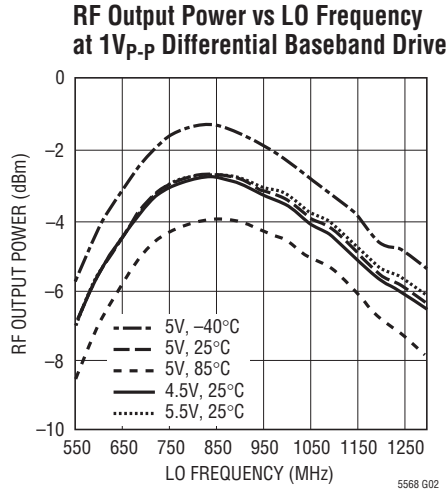
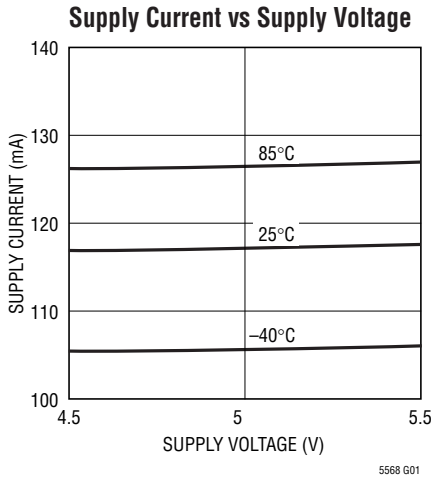

TYPICAL PERFORMANCE CHARACTERISTICS $V_{CC} = 5V$, $EN = High$, $T_A = 25^\circ C$, $f_{LO} = 850MHz$, $P_{LO} = 0dBm$. BBPI, BBMI, BBPQ, BBMQ inputs $0.54V_{DC}$, Baseband Input Frequency $f_{BB} = 2MHz$, I&Q 90° shifted. $f_{RF} = f_{BB} + f_{LO}$ (upper sideband selection). $P_{RF, OUT} = -10dBm$ (-10dBm/tone for 2-tone measurements), unless otherwise noted. (Note 3)

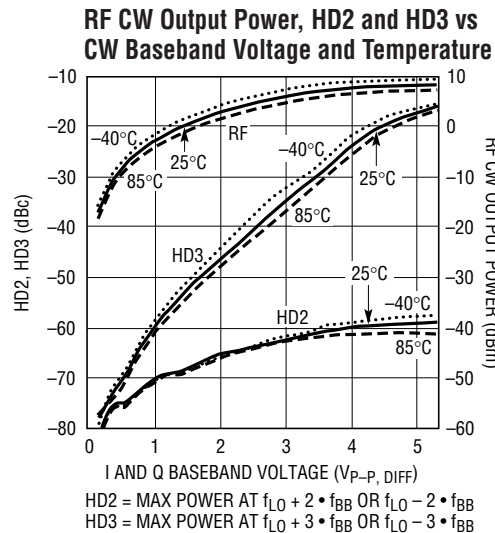
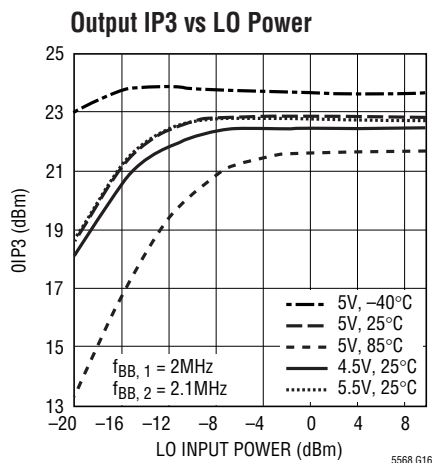
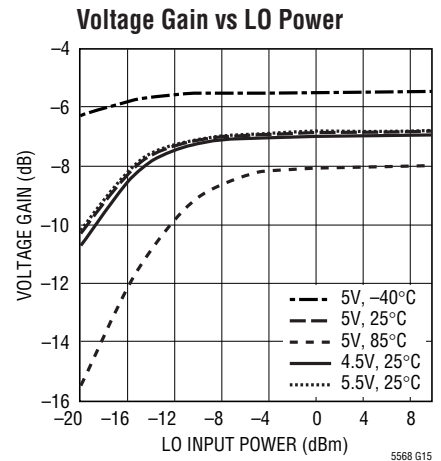
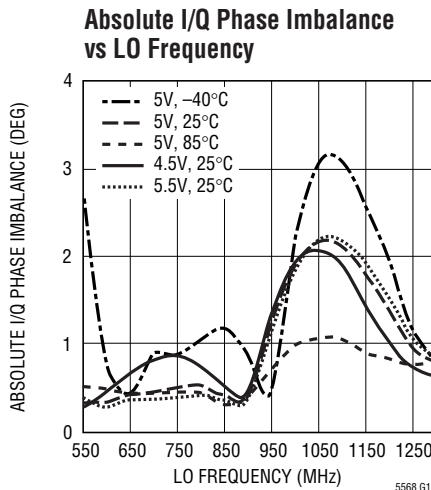
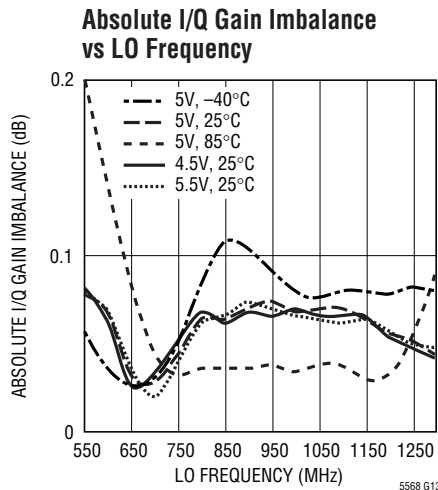
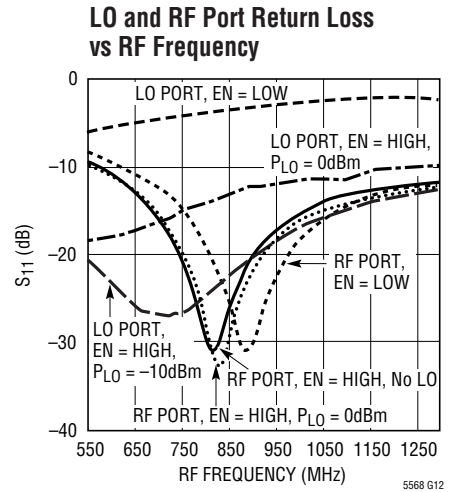
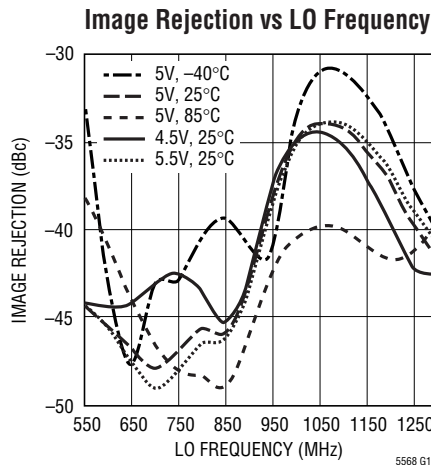
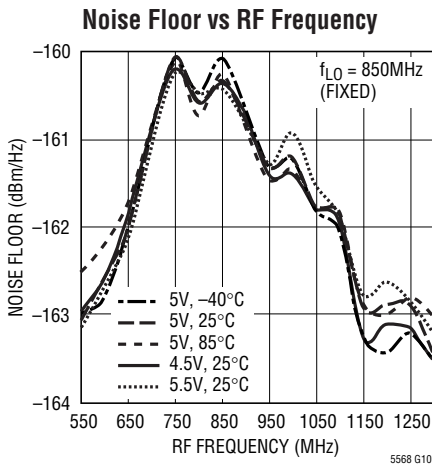

TYPICAL PERFORMANCE CHARACTERISTICS $V_{CC} = 5V$, $EN = High$, $T_A = 25^\circ C$, $f_{LO} = 850MHz$, $P_{LO} = 0dBm$. BBPI, BBMI, BBPQ, BBMQ inputs $0.54V_{DC}$, Baseband Input Frequency $f_{BB} = 2MHz$, I&Q 90° shifted. $f_{RF} = f_{BB} + f_{LO}$ (upper sideband selection). $P_{RF, OUT} = -10dBm$ (-10dBm/tone for 2-tone measurements), unless otherwise noted. (Note 3)

RF CW Output Power, HD2 and HD3 vs CW Baseband Voltage and Supply Voltage

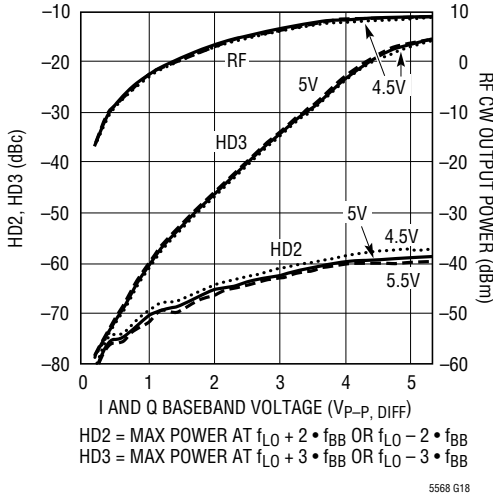

LO Feedthrough to RF Output vs CW Baseband Voltage

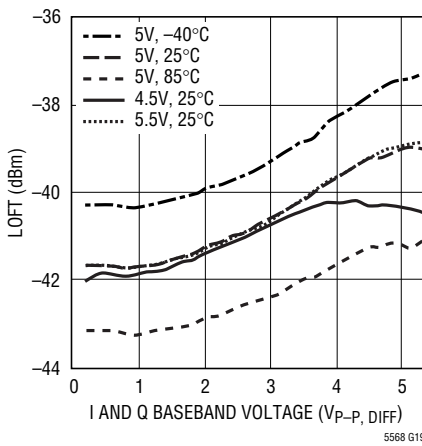
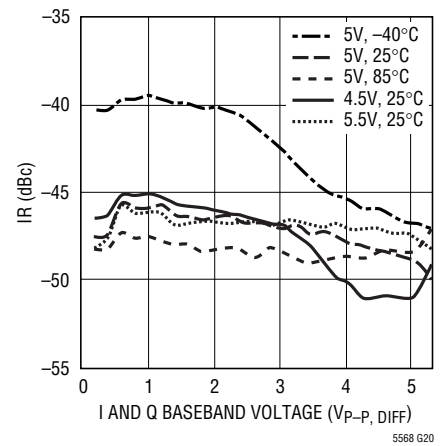
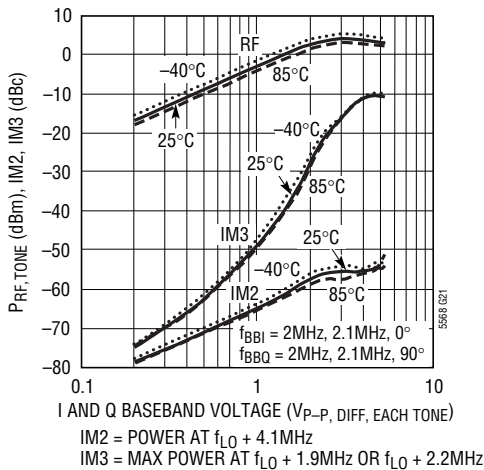

Image Rejection vs CW Baseband Voltage



RF Two-Tone Power (Each Tone), IM2 and IM3 vs Baseband Voltage and Temperature



RF Two-Tone Power (Each Tone), IM2 and IM3 vs Baseband Voltage and Supply Voltage

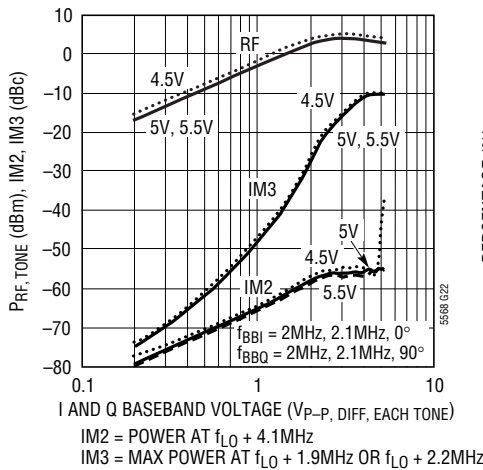

Gain Distribution

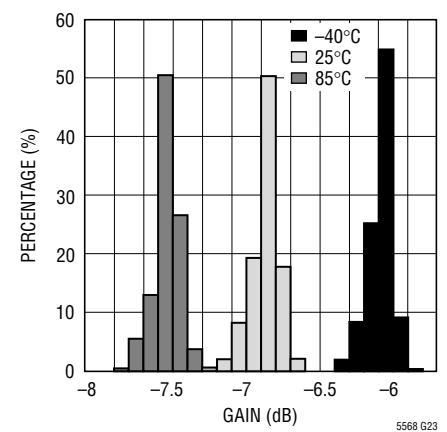

Noise Floor Distribution

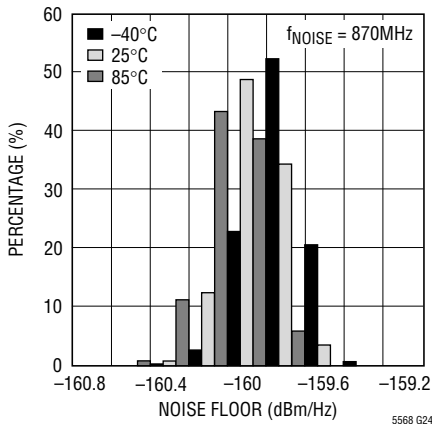

LO Leakage Distribution

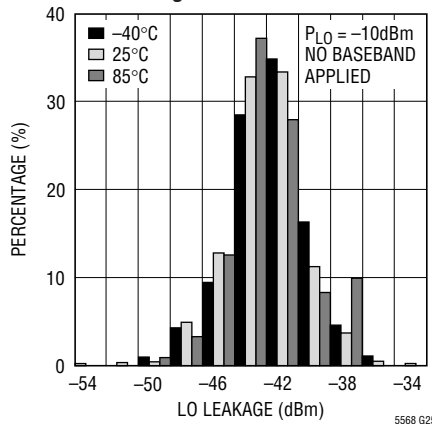
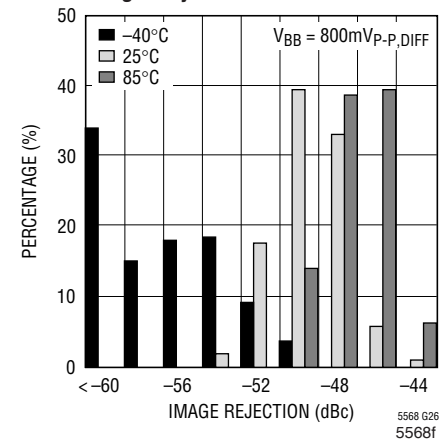

Image Rejection Distribution



PIN FUNCTIONS

EN (Pin 1): Enable Input. When the enable pin voltage is higher than 1V, the IC is turned on. When the input voltage is less than 0.5V, the IC is turned off.

GND (Pins 2, 4, 6, 9, 10, 12, 15): Ground. Pins 6, 9, 15 and 17 (exposed pad) are connected to each other internally. Pins 2 and 4 are connected to each other internally and function as the ground return for the LO signal. Pins 10 and 12 are connected to each other internally and function as the ground return for the on-chip RF balun. For best RF performance, pins 2, 4, 6, 9, 10, 12, 15 and the Exposed Pad 17 should be connected to the printed circuit board ground plane.

LO (Pin 3): LO Input. The LO input is an AC-coupled single-ended input with approximately 50 Ω input impedance at RF frequencies. Externally applied DC voltage should be within the range -0.5V to $V_{CC} + 0.5\text{V}$ in order to avoid turning on ESD protection diodes.

BBPQ, BBMQ (Pins 7, 5): Baseband Inputs for the Q-channel, each 50 Ω input impedance. Internally biased at about 0.54V. Applied voltage must stay below 2.5V.

V_{CC} (Pins 8, 13): Power Supply. Pins 8 and 13 are connected to each other internally. It is recommended to use 0.1 μF capacitors for decoupling to ground on each of these pins.

RF (Pin 11): RF Output. The RF output is an AC-coupled single-ended output with approximately 50 Ω output impedance at RF frequencies. Externally applied DC voltage should be within the range -0.5V to $V_{CC} + 0.5\text{V}$ in order to avoid turning on ESD protection diodes.

BBPI, BBMI (Pins 14, 16): Baseband Inputs for the I-channel, each with 50 Ω input impedance. Internally biased at about 0.54V. Applied voltage must stay below 2.5V.

Exposed Pad (Pin 17): Ground. This pin must be soldered to the printed circuit board ground plane.

BLOCK DIAGRAM

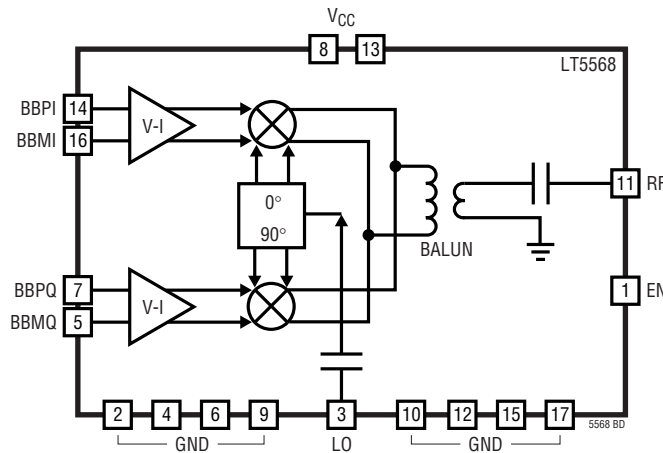

APPLICATIONS INFORMATION

The LT5568 consists of I and Q input differential voltage-to-current converters, I and Q up-conversion mixers, an RF output balun, an LO quadrature phase generator and LO buffers.

External I and Q baseband signals are applied to the differential baseband input pins, BBPI, BBMI, and BBPQ, BBMQ. These voltage signals are converted to currents and translated to RF frequency by means of double-balanced up-converting mixers. The mixer outputs are combined in an RF output balun, which also transforms the output impedance to 50Ω. The center frequency of the resulting RF signal is equal to the LO signal frequency. The LO input drives a phase shifter which splits the LO signal into in-phase and quadrature LO signals. These LO signals are then applied to on-chip buffers which drive the up-conversion mixers. Both the LO input and RF output are single-ended, 50Ω-matched and AC coupled.

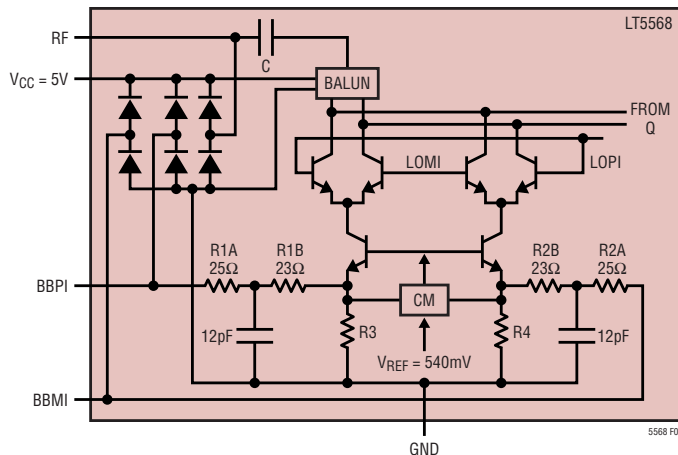

Figure 1. Simplified Circuit Schematic of the LT5568 (Only I-Half is Drawn)

Baseband Interface

The baseband inputs (BBPI, BBMI), (BBPQ, BBMQ) present a differential input impedance of about 100Ω. At each of the four baseband inputs, a first-order lowpass filter using 25Ω

APPLICATIONS INFORMATION

and 12pF to ground is incorporated (see Figure 1), which limits the baseband bandwidth to approximately 330MHz (−1dB point). The common mode voltage is about 0.54V and is approximately constant over temperature.

It is important that the applied common mode voltage level of the I and Q inputs is about 0.54V in order to properly bias the LT5568. Some I/Q test generators allow setting the common mode voltage independently. In this case, the common mode voltage of those generators must be set to 0.27V to match the LT5568 internal bias, because for DC signals, there is no −6dB source-load voltage division (see Figure 2).

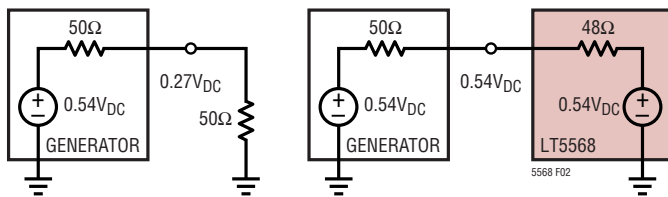

Figure 2. DC Voltage Levels for a Generator Programmed at 0.27V_{DC} for a 50Ω Load and the LT5568 as a Load

The baseband inputs should be driven differentially; otherwise, the even-order distortion products will degrade the overall linearity severely. Typically, a DAC will be the signal source for the LT5568. Reconstruction filters should be placed between the DAC output and the LT5568’s baseband inputs. In Figure 3, an example interface schematic shows a commonly used DAC output interface followed by a passive 5th order ladder filter. The DAC in this example sources a current from 0mA to 20mA. The interface may be DC coupled. This allows adjustment of the DAC’s differential output current to minimize the LO feedthrough. Optionally, transformer T1 can be inserted to improve the current balance in the BBPI and BBMI pins. This will improve the 2nd order distortion performance (OIP2).

The maximum single sideband CW RF output power at 850MHz using both I and Q channels with the configuration shown in Figure 3 is about −3dBm. The maximum CW output power can be increased by connecting load resistors R5 and R6 to −5V instead of GND, and changing their values to 550Ω. In that case, the maximum single sideband CW RF output power at 850MHz will be about +2dBm. In addition, the ladder filter component values require adjustment for a higher source impedance.

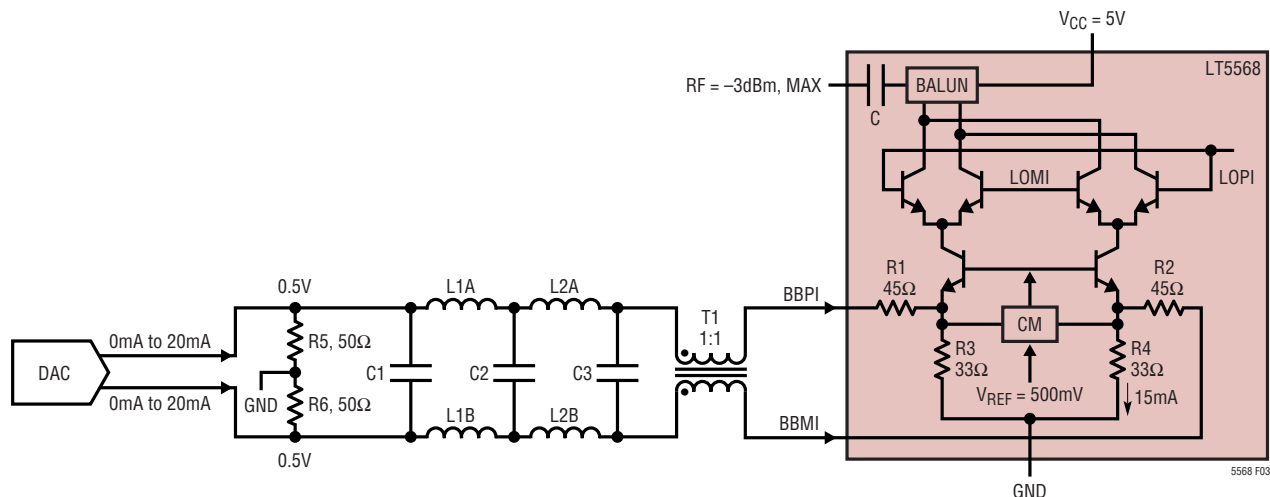

Figure 3. LT5568 5th Order Filtered Baseband Interface with Common DAC (Only I-Channel is Shown)

APPLICATIONS INFORMATION

LO Section

The internal LO input amplifier performs single-ended to differential conversion of the LO input signal. Figure 4 shows the equivalent circuit schematic of the LO input.

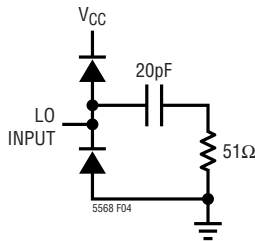

Figure 4. Equivalent Circuit Schematic of the LO Input

The internal, differential LO signal is then split into in-phase and quadrature (90° phase shifted) signals that drive LO buffer sections. These buffers drive the double balanced I and Q mixers. The phase relationship between the LO input and the internal in-phase LO and quadrature LO signals is fixed, and is independent of start-up conditions. The internal phase shifters are designed to deliver accurate quadrature signals. For LO frequencies significantly below 600MHz or above 1GHz, however, the quadrature accuracy will diminish, causing the image rejection to degrade. The LO pin input impedance is about 50Ω, and the recommended LO input power is 0dBm. For lower LO input power, the gain, OIP2, OIP3 and noise floor at $P_{RF} = 4\text{dBm}$ will degrade, especially below -5dBm and at $T_A = 85^\circ\text{C}$. For high LO input power (e.g., $+5\text{dBm}$), the LO feedthrough will increase with no improvement in linearity or gain. For lower LO input power, e.g., $P_{LO} = -5\text{dBm}$, the image rejection improves (especially around 950MHz) at the cost of 1.5dB degradation of the noise floor at $P_{RF} = 4\text{dBm}$. Harmonics present on the LO signal can degrade the image rejection because they can introduce a small excess phase shift in the internal phase splitter. For the second (at 1.7GHz) and third harmonics (at 2.55GHz) at -20dBc , the resulting signal at the image frequency is about -56dBc or lower, corresponding to an excess phase shift of much less than 1 degree. For the second and third LO harmonics at -10dBc , the introduced signal at the image frequency is about -47dBc . Higher harmonics than the third will have less impact. The LO return loss typically will be better than 11dB over the 700MHz to 1.05GHz range. Table 1 shows the LO port input impedance vs frequency.

Table 1. LO Port Input Impedance vs Frequency for EN = High and $P_{LO} = 0\text{dBm}$

| Frequency MHz | Input Impedance Ω | S_{11} | |
|------------------|-----------------------------|----------|-------|
| | | Mag | Angle |
| 500 | $47.5 + j12.1$ | 0.126 | 95.0 |
| 600 | $59.4 + j8.4$ | 0.115 | 37.8 |
| 700 | $66.2 - j1.14$ | 0.140 | -3.41 |
| 800 | $67.2 - j13.4$ | 0.185 | -31.7 |
| 900 | $61.1 - j23.9$ | 0.232 | -53.2 |
| 1000 | $53.3 - j26.8$ | 0.252 | -68.7 |
| 1100 | $48.2 - j26.1$ | 0.258 | -79.4 |
| 1200 | $42.0 - j27.4$ | 0.297 | -90.0 |

If the part is in shutdown mode, the input impedance of the LO port will be different. The LO input impedance for EN = Low is given in Table 2.

Table 2. LO Port Input Impedance vs Frequency for EN = Low and $P_{LO} = 0\text{dBm}$

| Frequency MHz | Input Impedance Ω | S_{11} | |
|------------------|-----------------------------|----------|-------|
| | | Mag | Angle |
| 500 | $33.6 + j41.3$ | 0.477 | 85.4 |
| 600 | $59.8 + j69.1$ | 0.539 | 49.8 |
| 700 | $140 + j89.8$ | 0.606 | 19.6 |
| 800 | $225 - j62.6$ | 0.659 | -6.8 |
| 900 | $92.9 - j128$ | 0.704 | -29.6 |
| 1000 | $39.8 - j95.9$ | 0.735 | -45.5 |
| 1100 | $22.8 - j72.7$ | 0.755 | -65.6 |
| 1200 | $16.0 - j57.3$ | 0.763 | -79.7 |

RF Section

After up-conversion, the RF outputs of the I and Q mixers are combined. An on-chip balun performs internal differential to single-ended output conversion, while transforming the output signal impedance to 50Ω. Table 3 shows the RF port output impedance vs frequency.

Table 3. RF Port Output Impedance vs Frequency for EN = High and $P_{LO} = 0\text{dBm}$

| Frequency MHz | Input Impedance Ω | S_{22} | |
|------------------|-----------------------------|----------|--------|
| | | Mag | Angle |
| 500 | $22.0 + j5.7$ | 0.395 | 164.2 |
| 600 | $28.2 + j12.5$ | 0.317 | 141.3 |
| 700 | $38.8 + j14.8$ | 0.206 | 117.5 |
| 800 | $49.4 + j7.2$ | 0.072 | 90.6 |
| 900 | $49.3 - j5.1$ | 0.051 | -94.7 |
| 1000 | $42.5 - j11.1$ | 0.143 | -117.0 |
| 1100 | $36.7 - j11.7$ | 0.202 | -130.7 |
| 1200 | $33.0 - j10.3$ | 0.238 | -141.6 |

5568f

APPLICATIONS INFORMATION

The RF output S_{22} with no LO power applied is given in Table 4.

Table 4. RF Port Output Impedance vs Frequency for EN = High and No LO Power Applied

| Frequency MHz | Input Impedance Ω | S_{22} | |
|---------------|--------------------------|----------|--------|
| | | Mag | Angle |
| 500 | 22.7 + j5.6 | 0.381 | 164.0 |
| 600 | 29.7 + j11.6 | 0.290 | 142.0 |
| 700 | 40.5 + j11.6 | 0.164 | 121.9 |
| 800 | 47.3 + j2.2 | 0.037 | 139.6 |
| 900 | 44.1 - j6.7 | 0.094 | -126.9 |
| 1000 | 38.2 - j9.8 | 0.171 | -133.9 |
| 1100 | 34.0 - j9.4 | 0.218 | -143.1 |
| 1200 | 31.5 - j7.8 | 0.245 | -151.6 |

For EN = Low the S_{22} is given in Table 5.

Table 5. RF Port Output Impedance vs Frequency for EN = Low

| Frequency MHz | Input Impedance Ω | S_{22} | |
|---------------|--------------------------|----------|--------|
| | | Mag | Angle |
| 500 | 21.2 + j5.4 | 0.409 | 164.9 |
| 600 | 26.6 + j12.5 | 0.340 | 142.5 |
| 700 | 36.6 + j16.6 | 0.241 | 118.1 |
| 800 | 49.2 + j11.6 | 0.116 | 87.4 |
| 900 | 52.9 - j2.0 | 0.034 | -33.1 |
| 1000 | 46.4 - j11.2 | 0.121 | -101.1 |
| 1100 | 39.3 - j13.2 | 0.188 | -120.6 |
| 1200 | 34.4 - j12.1 | 0.231 | -133.8 |

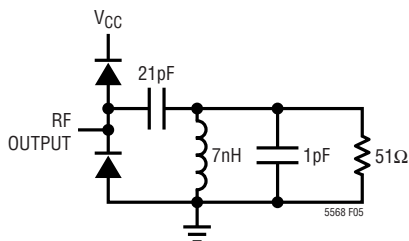

Figure 5. Equivalent Circuit Schematic of the RF Output

Note that an ESD diode is connected internally from the RF output to ground. For strong output RF signal levels (higher than 3dBm), this ESD diode can degrade the linearity performance if the 50 Ω termination impedance is connected directly to ground. To prevent this, a coupling capacitor can be inserted in the RF output line. This is strongly recommended during a 1dB compression measurement.

Enable Interface

Figure 6 shows a simplified schematic of the EN pin interface. The voltage necessary to turn on the LT5568 is 1V. To disable (shut down) the chip, the enable voltage must be below 0.5V. If the EN pin is not connected, the chip is disabled. This EN = Low condition is assured by the 75k on-chip pull-down resistor. It is important that the voltage at the EN pin does not exceed V_{CC} by more than 0.5V. If this should occur, the supply current could be sourced through the EN pin ESD protection diodes, which are not designed to carry the full supply current, and damage may result.

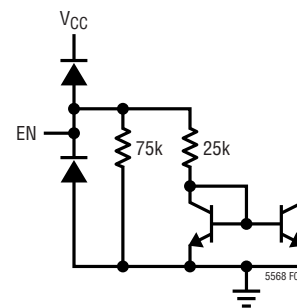

Figure 6. EN Pin Interface

APPLICATIONS INFORMATION

Evaluation Board

Figure 7 shows the evaluation board schematic. A good ground connection is required for the exposed pad. If this is not done properly, the RF performance will degrade. Additionally, the exposed pad provides heat sinking for the part and minimizes the possibility of the chip overheating.

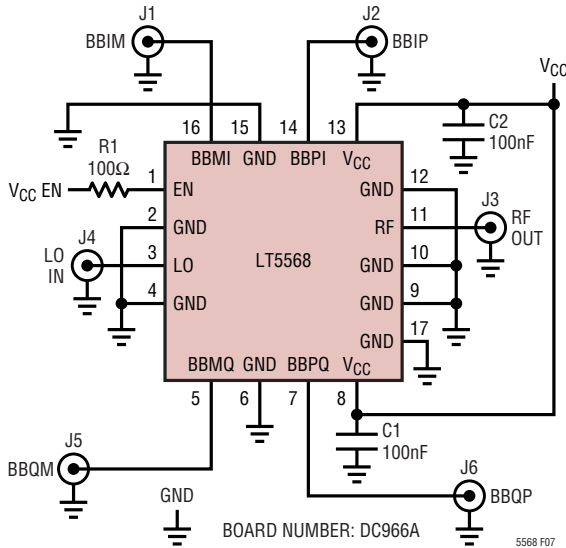

Figure 7. Evaluation Circuit Schematic

R1 (optional) limits the EN pin current in the event that the EN pin is pulled high while the V_{CC} inputs are low. In Figures 8 and 9 the silk screens and the PCB board layout are shown.

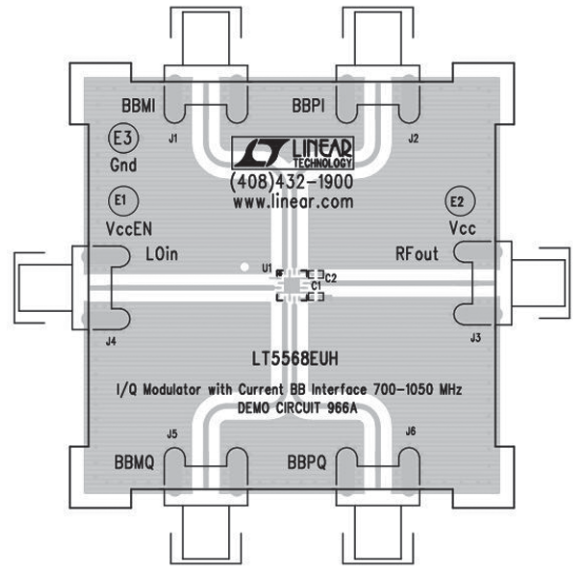

Figure 8. Component Side of Evaluation Board

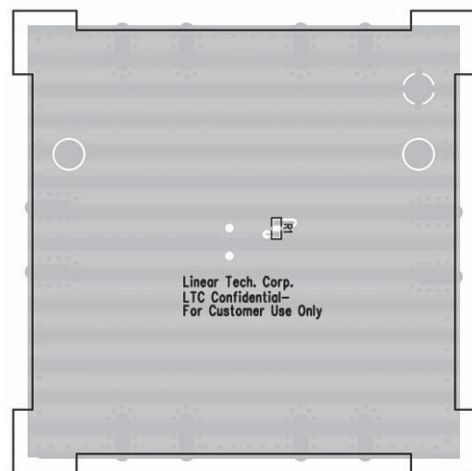

Figure 9. Bottom Side of Evaluation Board

APPLICATIONS INFORMATION

Application Measurements

The LT5568 is recommended for base-station applications using various modulation formats. Figure 10 shows a typical application. Figure 11 shows the ACPR performance for CDMA2000 using 1- and 3-carrier modulation. Figures 12 and 13 illustrate the 1- and 3-carrier CDMA2000 RF spectrum. To calculate ACPR, a correction is made for the spectrum analyzer noise floor. If the output power is high, the ACPR will be limited by the linearity performance of the part. If the output power is low, the ACPR will be limited by the noise performance of the part. In the middle, an optimum ACPR is observed.

Because of the LT5568's very high dynamic range, the test equipment can limit the accuracy of the ACPR measure-

ment. See Application Note 99. Consult the factory for advice on the ACPR measurement, if needed.

The ACPR performance is sensitive to the amplitude match of the BBIP and BBIM (or BBQP and BBQM) inputs. This is because a difference in AC current amplitude will give rise to a difference in amplitude between the even-order harmonic products generated in the internal V-I converter. As a result, they will not cancel out entirely. Therefore, it is important to keep the currents in those pins exactly the same (but of opposite sign). The current will enter the LT5568's common-base stage, and will flow to the mixer upper switches. This can be seen in Figure 1 where the internal circuit of the LT5568 is drawn. For best results, a high ohmic source is recommended; for example, the

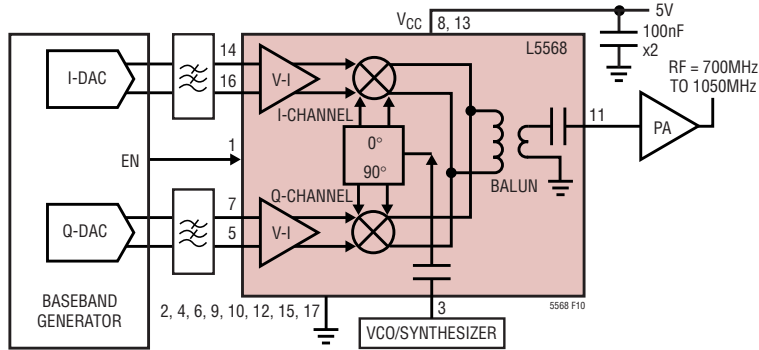

Figure 10. 700MHz to 1050MHz Direct Conversion Transmitter Application

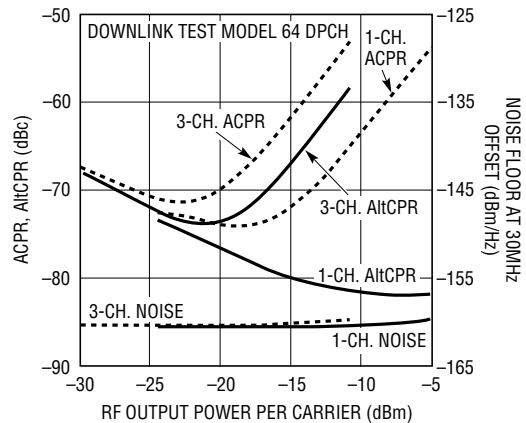

Figure 11. APCR, AltCPR and Noise CDMA2000 Modulation

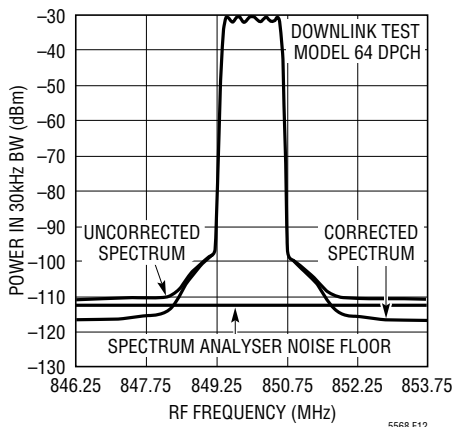

Figure 12. 1-Carrier CDMA2000 Spectrum

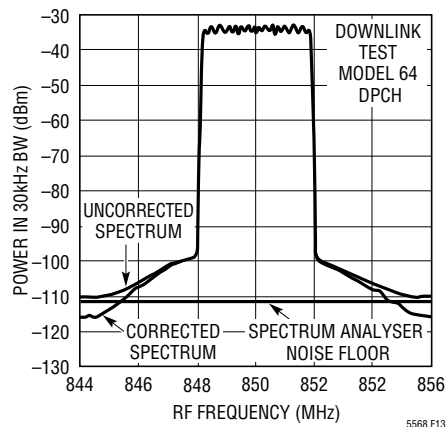

Figure 13. 3-Carrier CDMA2000 Spectrum

APPLICATIONS INFORMATION

interface circuit drawn in Figure 3, modified by pulling resistors R5 and R6 to a -5V supply and adjusting their values to 550Ω, with T1 omitted.

Another method to reduce current mismatch between the currents flowing in the BBIP and BBIM pins (or the BBQP and BBQM pins) is to use a 1:1 transformer with the two windings in the DC path (T1 in Figure 3). For DC, the transformer forms a short, and for AC, the transformer will reduce the common mode current component, which forces the two currents to be better matched. Alternatively, a transformer with 1:2 impedance ratio can be used, which gives a convenient DC separation between primary and secondary in combination with the required impedance

match. The secondary center tap should not be connected, which allows some voltage swing if there is a single-ended input impedance difference at the baseband pins. As a result, both currents will be equal. The disadvantage is that there is no DC coupling, so the LO feedthrough calibration cannot be performed via the BB connections. After calibration when the temperature changes, the LO feedthrough and the image rejection performance will change. This is illustrated in Figure 14. The LO feedthrough and image rejection can also change as a function of the baseband drive level, as is depicted in Figure 15. In Figures 16 and 17 the LO feedthrough and image rejection vs LO power are shown.

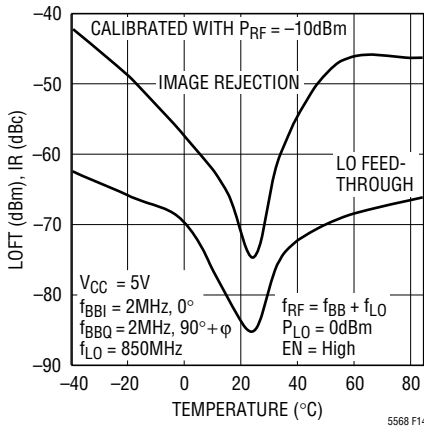

Figure 14. LO Feedthrough and Image Rejection vs Temperature after Calibration at 25°C

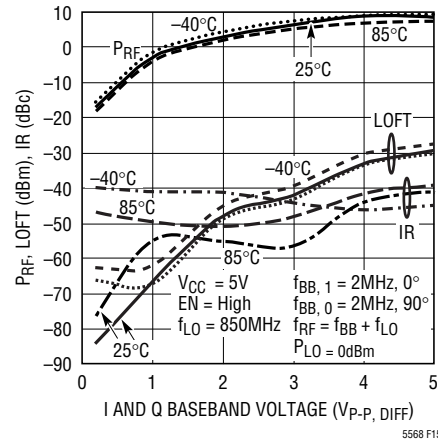

Figure 15. LO Feedthrough and Image Rejection vs Baseband Drive Voltage after Calibration at 25°C

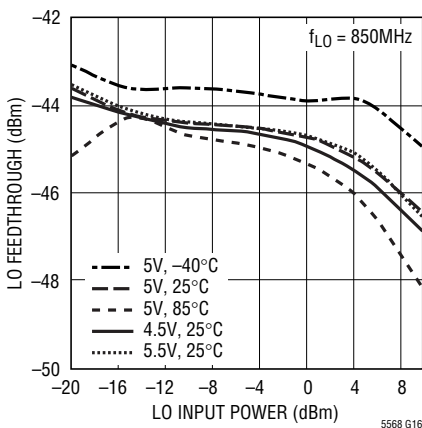

Figure 16. LO Feedthrough vs LO Power

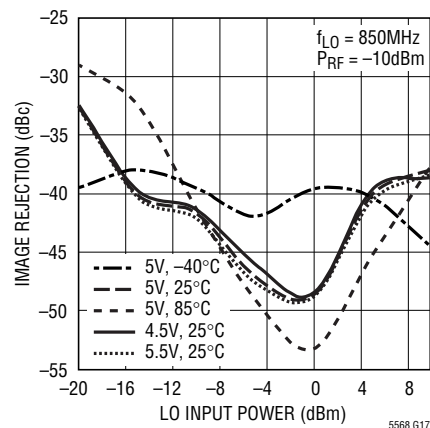
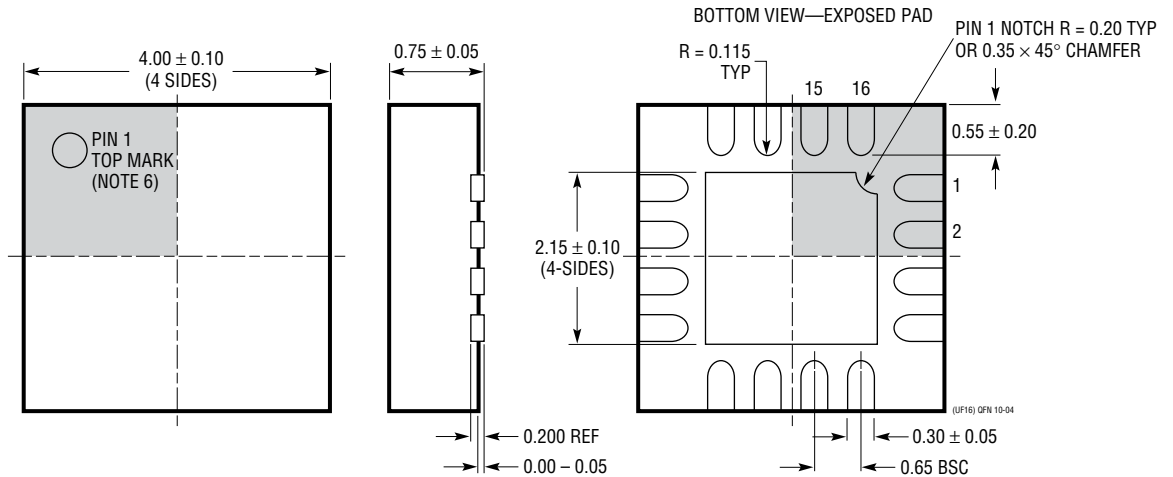
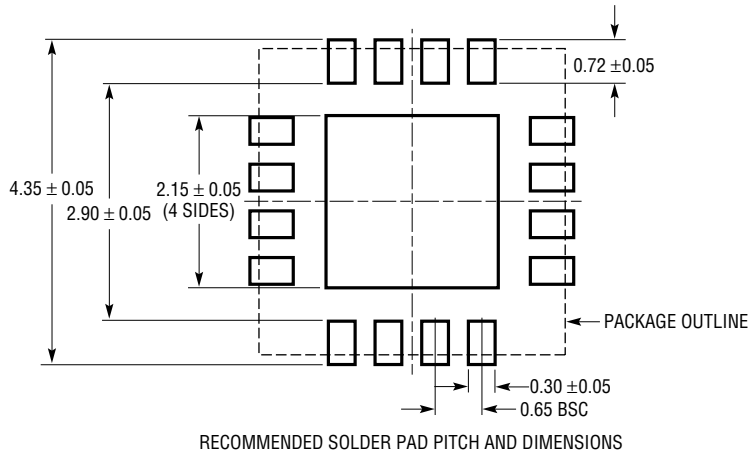

Figure 17. Image Rejection vs LO Power

PACKAGE DESCRIPTION

UF Package
16-Lead Plastic QFN (4mm × 4mm)
 (Reference LTC DWG # 05-08-1692)



- NOTE:
1. DRAWING CONFORMS TO JEDEC PACKAGE OUTLINE MO-220 VARIATION (WGFC)
 2. DRAWING NOT TO SCALE
 3. ALL DIMENSIONS ARE IN MILLIMETERS
 4. DIMENSIONS OF EXPOSED PAD ON BOTTOM OF PACKAGE DO NOT INCLUDE MOLD FLASH. MOLD FLASH, IF PRESENT, SHALL NOT EXCEED 0.15mm ON ANY SIDE
 5. EXPOSED PAD SHALL BE SOLDER PLATED
 6. SHADED AREA IS ONLY A REFERENCE FOR PIN 1 LOCATION ON THE TOP AND BOTTOM OF PACKAGE

RELATED PARTS

| PART NUMBER | DESCRIPTION | COMMENTS |
|---------------------------|---|--|
| Infrastructure | | |
| LT5511 | High Linearity Upconverting Mixer | RF Output to 3GHz, 17dBm IIP3, Integrated LO Buffer |
| LT5512 | DC to 3GHz High Signal Level Downconverting Mixer | DC to 3GHz, 17dBm IIP3, Integrated LO Buffer |
| LT5514 | Ultralow Distortion, IF Amplifier/ADC Driver with Digitally Controlled Gain | 850MHz Bandwidth, 47dBm OIP3 at 100MHz, 10.5dB to 33dB Gain Control Range |
| LT5515 | 1.5GHz to 2.5GHz Direct Conversion Quadrature Demodulator | 20dBm IIP3, Integrated LO Quadrature Generator |
| LT5516 | 0.8GHz to 1.5GHz Direct Conversion Quadrature Demodulator | 21.5dBm IIP3, Integrated LO Quadrature Generator |
| LT5517 | 40MHz to 900MHz Quadrature Demodulator | 21dBm IIP3, Integrated LO Quadrature Generator |
| LT5518 | 1.5GHz to 2.4GHz High Linearity Direct Quadrature Modulator | 22.8dBm OIP3 at 2GHz, -158.2dBm/Hz Noise Floor, 50Ω Single-Ended LO and RF Ports, 4-Ch W-CDMA ACPR = -64dBc at 2.14GHz |
| LT5519 | 0.7GHz to 1.4GHz High Linearity Upconverting Mixer | 17.1dBm IIP3 at 1GHz, Integrated RF Output Transformer with 50Ω Matching, Single-Ended LO and RF Ports Operation |
| LT5520 | 1.3GHz to 2.3GHz High Linearity Upconverting Mixer | 15.9dBm IIP3 at 1.9GHz, Integrated RF Output Transformer with 50Ω Matching, Single-Ended LO and RF Ports Operation |
| LT5521 | 10MHz to 3700MHz High Linearity Upconverting Mixer | 24.2dBm IIP3 at 1.95GHz, NF = 12.5dB, 3.15V to 5.25V Supply, Single-Ended LO Port Operation |
| LT5522 | 600MHz to 2.7GHz High Signal Level Downconverting Mixer | 4.5V to 5.25V Supply, 25dBm IIP3 at 900MHz, NF = 12.5dB, 50Ω Single-Ended RF and LO Ports |
| LT5524 | Low Power, Low Distortion ADC Driver with Digitally Programmable Gain | 450MHz Bandwidth, 40dBm OIP3, 4.5dB to 27dB Gain Control |
| LT5526 | High Linearity, Low Power Downconverting Mixer | 3V to 5.3V Supply, 16.5dBm IIP3, 100kHz to 2GHz RF, NF = 11dB, I _{CC} = 28mA, -65dBm LO-RF Leakage |
| LT5527 | 400MHz to 3.7GHz High Signal Level Downconverting Mixer | IIP3 = 23.5dBm and NF = 12.5dB at 1900MHz, 4.5V to 5.25V Supply, I _{CC} = 78mA |
| LT5528 | 1.5GHz to 2.4GHz High Linearity Direct Quadrature Modulator | 21.8dBm OIP3 at 2GHz, -159.3dBm/Hz Noise Floor, 50Ω, 0.5V _{DC} Baseband Interface, 4-Ch W-CDMA ACPR = -66dBc at 2.14GHz |
| RF Power Detectors | | |
| LTC®5505 | RF Power Detectors with >40dB Dynamic Range | 300MHz to 3GHz, Temperature Compensated, 2.7V to 6V Supply |
| LTC5507 | 100kHz to 1000MHz RF Power Detector | 100kHz to 1GHz, Temperature Compensated, 2.7V to 6V Supply |
| LTC5508 | 300MHz to 7GHz RF Power Detector | 44dB Dynamic Range, Temperature Compensated, SC70 Package |
| LTC5509 | 300MHz to 3GHz RF Power Detector | 36dB Dynamic Range, Low Power Consumption, SC70 Package |
| LTC5532 | 300MHz to 7GHz Precision RF Power Detector | Precision V _{OUT} Offset Control, Adjustable Gain and Offset |
| LT5534 | 50MHz to 3GHz Loq RF Power Detector with 60dB Dynamic Range | ±1dB Output Variation over Temperature, 38ns Response Time |
| LTC5536 | Precision 600MHz to 7GHz RF Detector with Fast Comparater | 25ns Response Time, Comparator Reference Input, Latch Enable Input, -26dBm to +12dBm Input Range |
| LT5537 | Wide Dynamic Range Loq RF/IF Detector | Low Frequency to 800MHz, 83dB Dynamic Range, 2.7V to 5.25V Supply |
| High Speed ADCs | | |
| LTC2220-1 | 12-Bit, 185Msps ADC | Single 3.3V Supply, 910mW Consumption, 67.5dB SNR, 80dB SFDR, 775MHz Full Power BW |
| LTC2249 | 14-Bit, 80Msps ADC | Single 3V Supply, 222mW Consumption, 73dB SNR, 90dB SFDR |
| LTC2255 | 14-Bit, 125Msps ADC | Single 3V Supply, 395mW Consumption, 72.4dB SNR, 88dB SFDR, 640MHz Full Power BW |